

# DATA SHEET

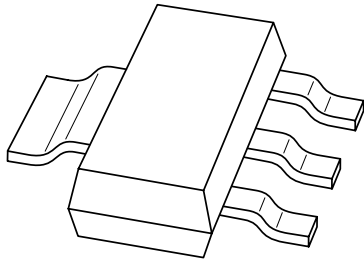

**PBSS4350Z**

**50 V low  $V_{CEsat}$  NPN transistor**

Product specification  
Supersedes data of 2001 Jul 13

2003 Jan 20

# 50 V low $V_{CEsat}$ NPN transistor

# PBSS4350Z

## FEATURES

- Low collector-emitter saturation voltage
- High collector current capability:  $I_C$  and  $I_{CM}$
- High collector current gain ( $h_{FE}$ ) at high  $I_C$
- Higher efficiency leading to less heat generation
- Reduced PCB area requirements compared to DPAK.

## APPLICATIONS

- Power management
  - DC/DC converters
  - Supply line switching
  - Battery charger
  - Linear voltage regulation (LDO).
- Peripheral drivers
  - Driver in low supply voltage applications, e.g. lamps, LEDs
  - Inductive load driver, e.g. relays, buzzers, motors.

## DESCRIPTION

NPN low  $V_{CEsat}$  transistor in a SOT223 plastic package.  
PNP complement: PBSS5350Z.

## MARKING

TYPE NUMBER	MARKING CODE
PBSS4350Z	PB4350

## QUICK REFERENCE DATA

SYMBOL	PARAMETER	MAX.	UNIT
$V_{CEO}$	collector-emitter voltage	50	V
$I_{CM}$	peak collector current	5	A
$R_{CEsat}$	equivalent on-resistance	<145	m $\Omega$

## PINNING

PIN	DESCRIPTION
1	base
2	collector
3	emitter
4	collector

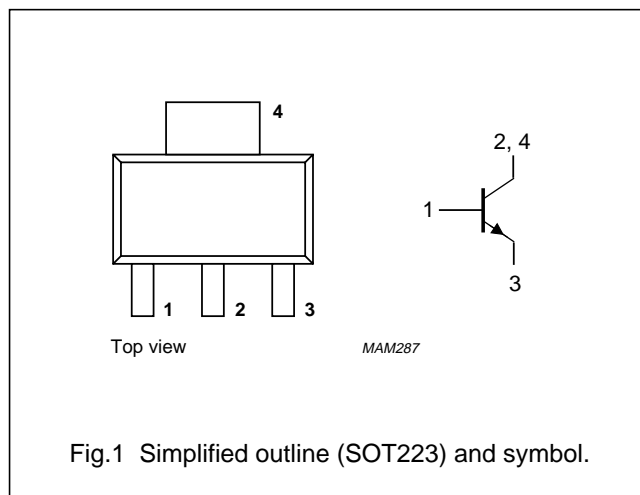

50 V low  $V_{CEsat}$  NPN transistor

PBSS4350Z

**LIMITING VALUES**

In accordance with the Absolute Maximum Rating System (IEC 60134).

SYMBOL	PARAMETER	CONDITIONS	MIN.	MAX.	UNIT
$V_{CBO}$	collector-base voltage	open emitter	–	60	V
$V_{CEO}$	collector-emitter voltage	open base	–	50	V
$V_{EBO}$	emitter-base voltage	open collector	–	6	V
$I_C$	collector current (DC)		–	3	A
$I_{CM}$	peak collector current		–	5	A
$I_{BM}$	peak base current		–	1	A
$P_{tot}$	total power dissipation	$T_{amb} \leq 25\text{ °C}$ ; notes 1 and 3	–	1.35	W
		$T_{amb} \leq 25\text{ °C}$ ; notes 2 and 3	–	2	W
$T_{stg}$	storage temperature		–65	+150	°C
$T_j$	junction temperature		–	150	°C
$T_{amb}$	operating ambient temperature		–65	+150	°C

**Notes**

1. Device mounted on a printed-circuit board; single sided copper; tinplated; mounting pad for collector 1 cm<sup>2</sup>.
2. Device mounted on a printed-circuit board; single sided copper; tinplated; mounting pad for collector 6 cm<sup>2</sup>.
3. For other mounting conditions see “*Thermal considerations for SOT223 in the General Part of associated Handbook*”.

**THERMAL CHARACTERISTICS**

SYMBOL	PARAMETER	CONDITIONS	VALUE	UNIT
$R_{th\ j-a}$	thermal resistance from junction to ambient	in free air; notes 1 and 3	92	K/W
		in free air; notes 2 and 3	62.5	K/W

**Notes**

1. Device mounted on a printed-circuit board; single sided copper; tinplated; mounting pad for collector 1 cm<sup>2</sup>.
2. Device mounted on a printed-circuit board; single sided copper; tinplated; mounting pad for collector 6 cm<sup>2</sup>.
3. For other mounting conditions see “*Thermal considerations for SOT223 in the General Part of associated Handbook*”.

50 V low  $V_{CEsat}$  NPN transistor

PBSS4350Z

**CHARACTERISTICS** $T_{amb} = 25\text{ °C}$  unless otherwise specified.

SYMBOL	PARAMETER	CONDITIONS	MIN.	TYP.	MAX.	UNIT
$I_{CBO}$	collector-base cut-off current	$V_{CB} = 50\text{ V}; I_E = 0$	–	–	100	nA
		$V_{CB} = 50\text{ V}; I_E = 0; T_j = 150\text{ °C}$	–	–	50	$\mu\text{A}$
$I_{EBO}$	emitter-base cut-off current	$V_{EB} = 5\text{ V}; I_C = 0$	–	–	100	nA
$h_{FE}$	DC current gain	$V_{CE} = 2\text{ V}; I_C = 500\text{ mA}$	200	–	–	
		$V_{CE} = 2\text{ V}; I_C = 1\text{ A}; \text{note 1}$	200	–	–	
		$V_{CE} = 2\text{ V}; I_C = 2\text{ A}; \text{note 1}$	100	–	–	
$V_{CEsat}$	collector-emitter saturation voltage	$I_C = 500\text{ mA}; I_B = 50\text{ mA}$	–	–	90	mV
		$I_C = 1\text{ A}; I_B = 50\text{ mA}$	–	–	170	mV
		$I_C = 2\text{ A}; I_B = 200\text{ mA}; \text{note 1}$	–	–	290	mV
$R_{CEsat}$	equivalent on-resistance	$I_C = 2\text{ A}; I_B = 200\text{ mA}; \text{note 1}$	–	110	<145	$\text{m}\Omega$
$V_{BEsat}$	base-emitter saturation voltage	$I_C = 2\text{ A}; I_B = 200\text{ mA}; \text{note 1}$	–	–	1.2	V
$V_{BEon}$	base-emitter turn-on voltage	$V_{CE} = 2\text{ V}; I_C = 1\text{ A}; \text{note 1}$	–	–	1.1	V
$f_T$	transition frequency	$I_C = 100\text{ mA}; V_{CE} = 5\text{ V}; f = 100\text{ MHz}$	100	–	–	MHz
$C_C$	collector capacitance	$V_{CB} = 10\text{ V}; I_E = I_e = 0; f = 1\text{ MHz}$	–	–	30	pF

**Note**

1. Pulse test:  $t_p \leq 300\text{ }\mu\text{s}$ ;  $\delta \leq 0.02$ .

50 V low  $V_{CEsat}$  NPN transistor

PBSS4350Z

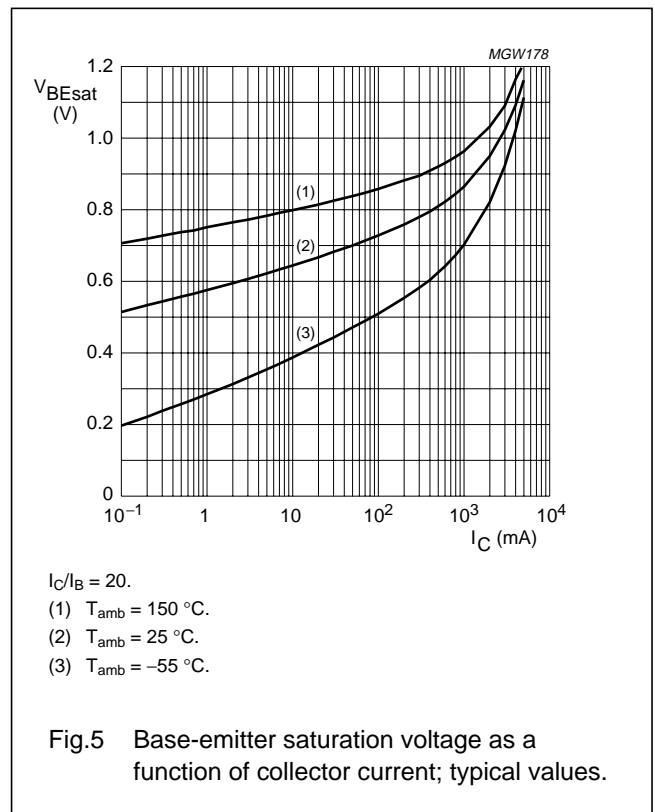
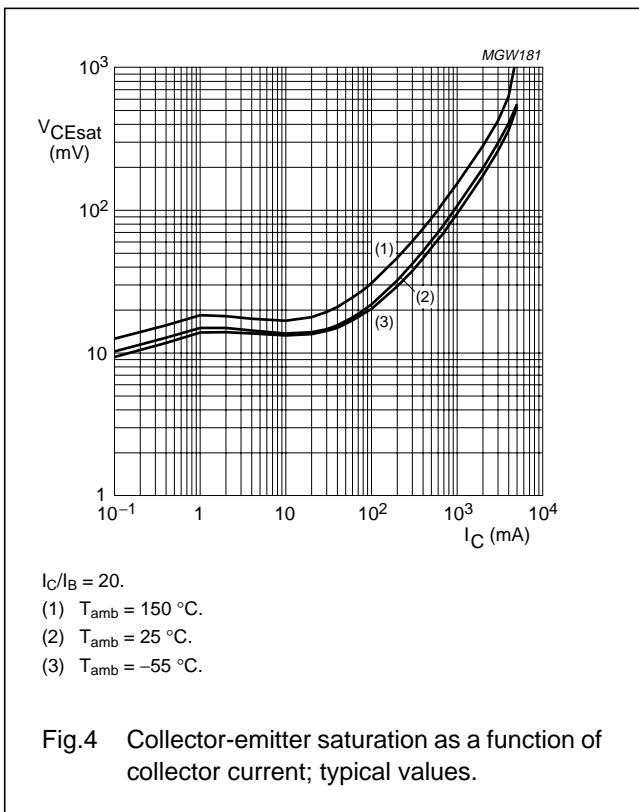
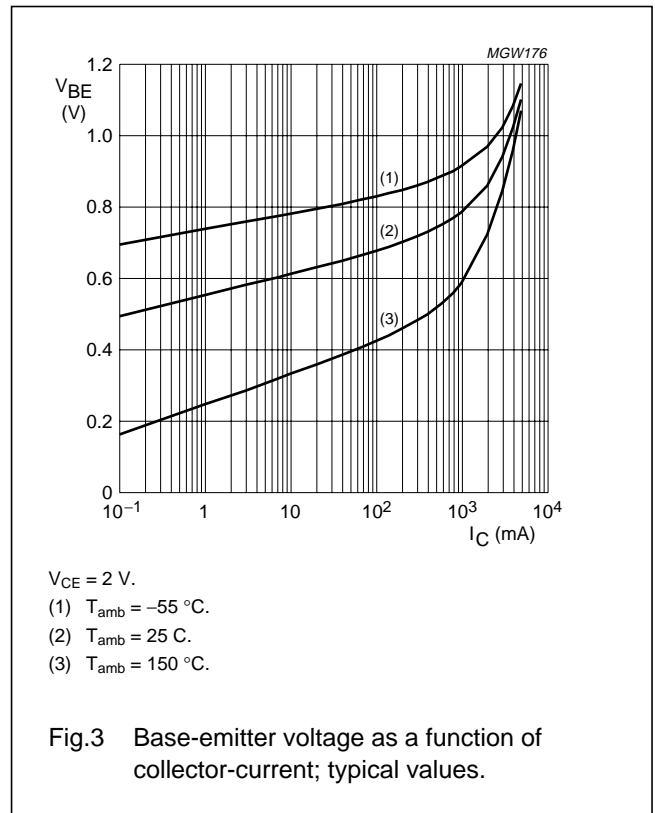
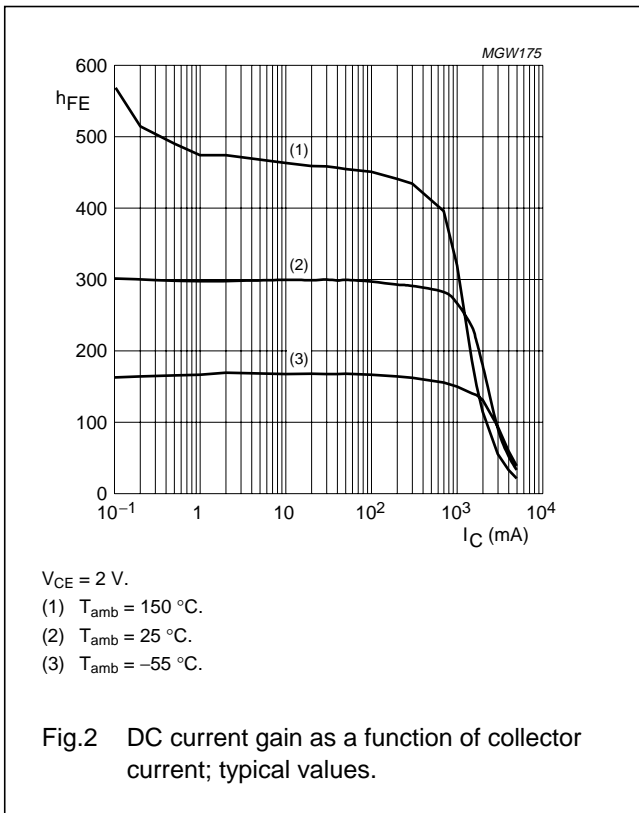

50 V low  $V_{CEsat}$  NPN transistor

PBSS4350Z

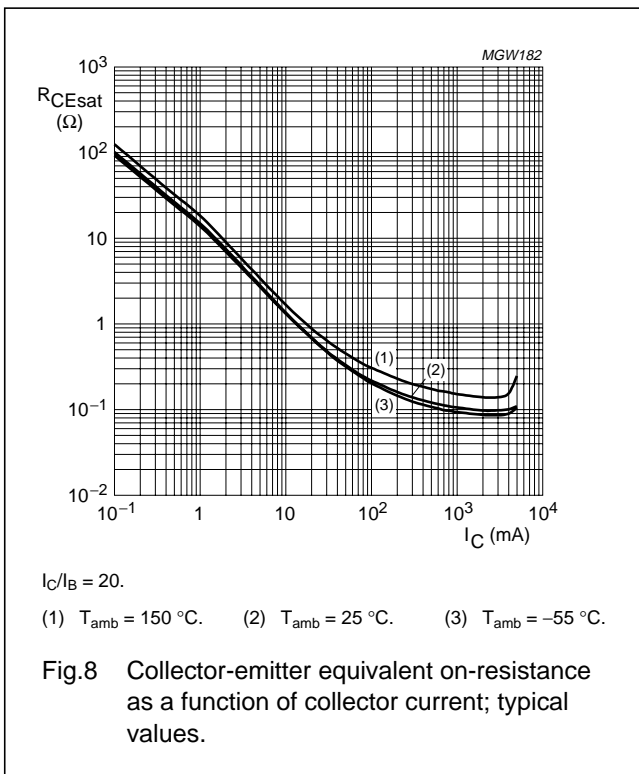
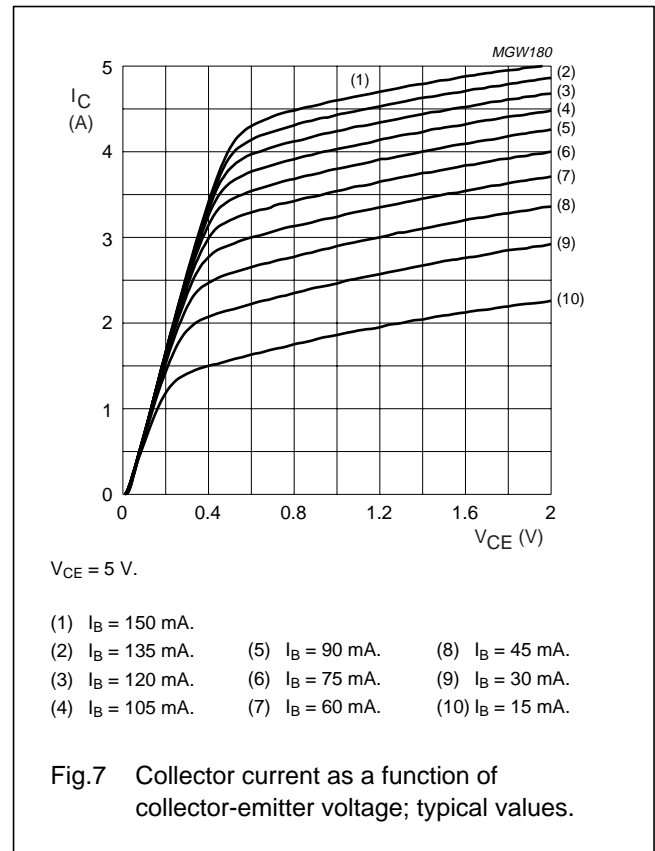
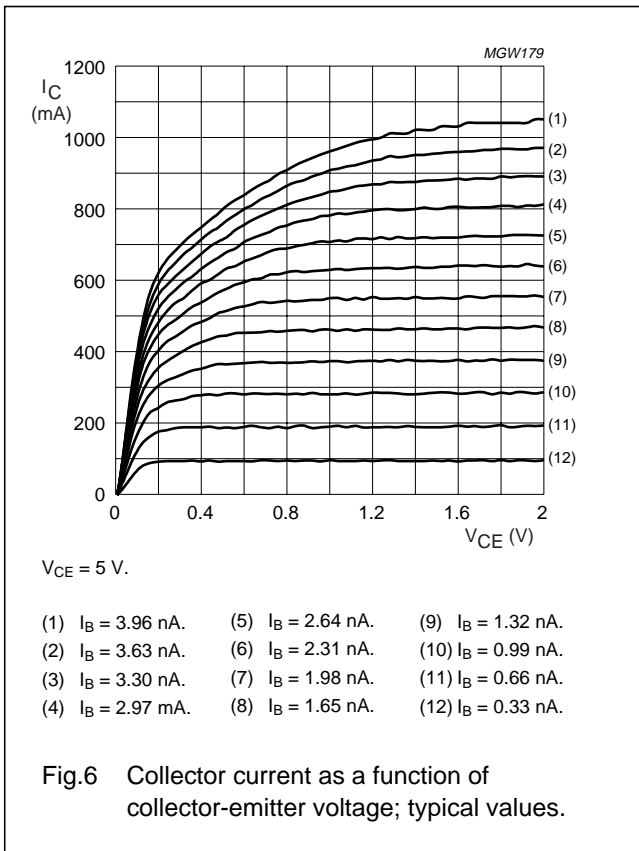

50 V low  $V_{CEsat}$  NPN transistor

PBSS4350Z

PACKAGE OUTLINE

Plastic surface mounted package; collector pad for good heat transfer; 4 leads

SOT223

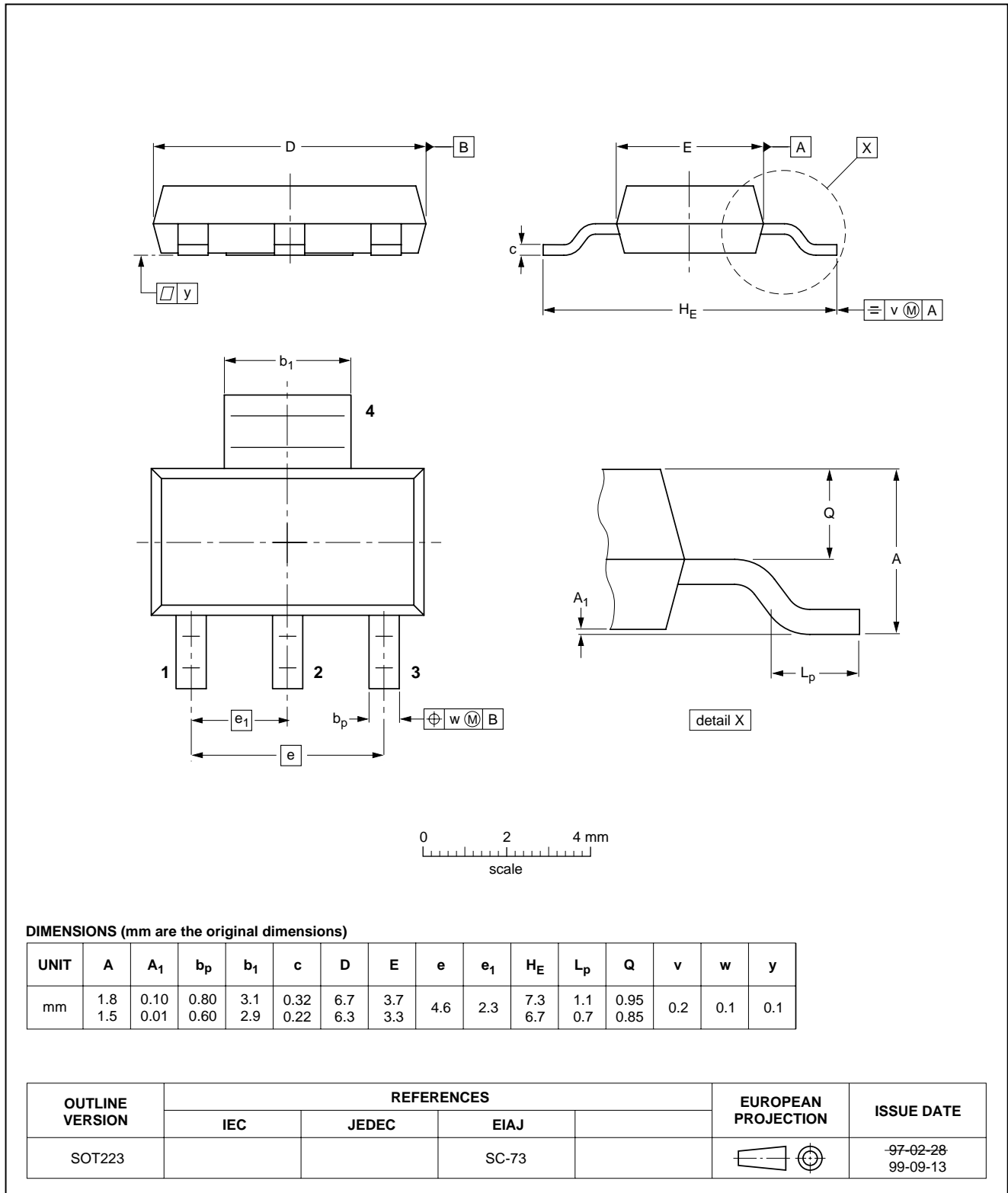

50 V low  $V_{CEsat}$  NPN transistor

PBSS4350Z

## DATA SHEET STATUS

LEVEL	DATA SHEET STATUS <sup>(1)</sup>	PRODUCT STATUS <sup>(2)(3)</sup>	DEFINITION
I	Objective data	Development	This data sheet contains data from the objective specification for product development. Philips Semiconductors reserves the right to change the specification in any manner without notice.
II	Preliminary data	Qualification	This data sheet contains data from the preliminary specification. Supplementary data will be published at a later date. Philips Semiconductors reserves the right to change the specification without notice, in order to improve the design and supply the best possible product.
III	Product data	Production	This data sheet contains data from the product specification. Philips Semiconductors reserves the right to make changes at any time in order to improve the design, manufacturing and supply. Relevant changes will be communicated via a Customer Product/Process Change Notification (CPCN).

## Notes

1. Please consult the most recently issued data sheet before initiating or completing a design.
2. The product status of the device(s) described in this data sheet may have changed since this data sheet was published. The latest information is available on the Internet at URL <http://www.semiconductors.philips.com>.
3. For data sheets describing multiple type numbers, the highest-level product status determines the data sheet status.

## DEFINITIONS

**Short-form specification** — The data in a short-form specification is extracted from a full data sheet with the same type number and title. For detailed information see the relevant data sheet or data handbook.

**Limiting values definition** — Limiting values given are in accordance with the Absolute Maximum Rating System (IEC 60134). Stress above one or more of the limiting values may cause permanent damage to the device. These are stress ratings only and operation of the device at these or at any other conditions above those given in the Characteristics sections of the specification is not implied. Exposure to limiting values for extended periods may affect device reliability.

**Application information** — Applications that are described herein for any of these products are for illustrative purposes only. Philips Semiconductors make no representation or warranty that such applications will be suitable for the specified use without further testing or modification.

## DISCLAIMERS

**Life support applications** — These products are not designed for use in life support appliances, devices, or systems where malfunction of these products can reasonably be expected to result in personal injury. Philips Semiconductors customers using or selling these products for use in such applications do so at their own risk and agree to fully indemnify Philips Semiconductors for any damages resulting from such application.

**Right to make changes** — Philips Semiconductors reserves the right to make changes in the products - including circuits, standard cells, and/or software - described or contained herein in order to improve design and/or performance. When the product is in full production (status 'Production'), relevant changes will be communicated via a Customer Product/Process Change Notification (CPCN). Philips Semiconductors assumes no responsibility or liability for the use of any of these products, conveys no licence or title under any patent, copyright, or mask work right to these products, and makes no representations or warranties that these products are free from patent, copyright, or mask work right infringement, unless otherwise specified.



50 V low  $V_{CEsat}$  NPN transistor

PBSS4350Z

---

**NOTES**

50 V low  $V_{CEsat}$  NPN transistor

PBSS4350Z

---

**NOTES**

50 V low  $V_{CEsat}$  NPN transistor

PBSS4350Z

---

**NOTES**

# ***Philips Semiconductors – a worldwide company***

## **Contact information**

For additional information please visit <http://www.semiconductors.philips.com>. Fax: +31 40 27 24825

For sales offices addresses send e-mail to: [sales.addresses@www.semiconductors.philips.com](mailto:sales.addresses@www.semiconductors.philips.com).

© Koninklijke Philips Electronics N.V. 2003

SCA75

All rights are reserved. Reproduction in whole or in part is prohibited without the prior written consent of the copyright owner.

The information presented in this document does not form part of any quotation or contract, is believed to be accurate and reliable and may be changed without notice. No liability will be accepted by the publisher for any consequence of its use. Publication thereof does not convey nor imply any license under patent- or other industrial or intellectual property rights.

Printed in The Netherlands

613514/02/pp12

Date of release: 2003 Jan 20

Document order number: 9397 750 10637

*Let's make things better.*

**Philips  
Semiconductors**



**PHILIPS**